

Αυτοκινητομολυβοχαρτοκυκλώματα (μικρά περιγράμματα)

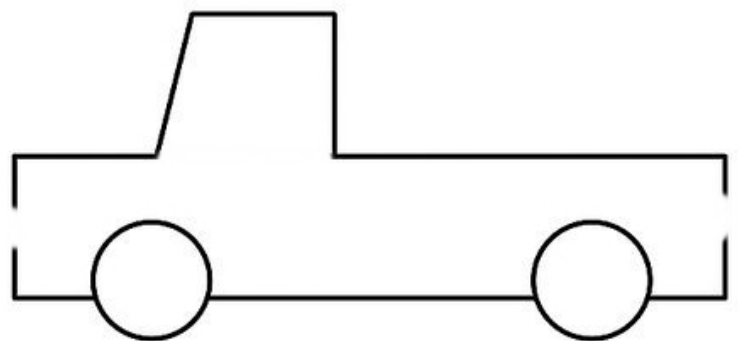

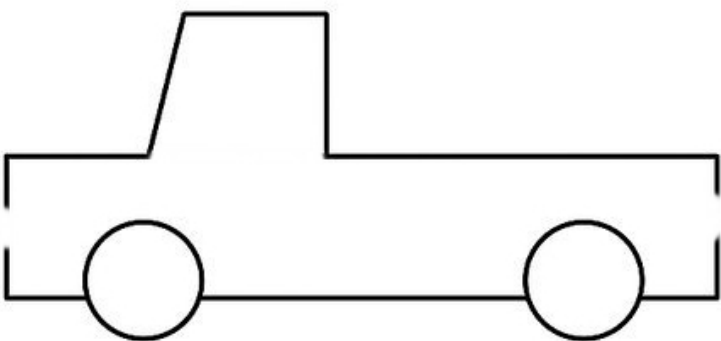
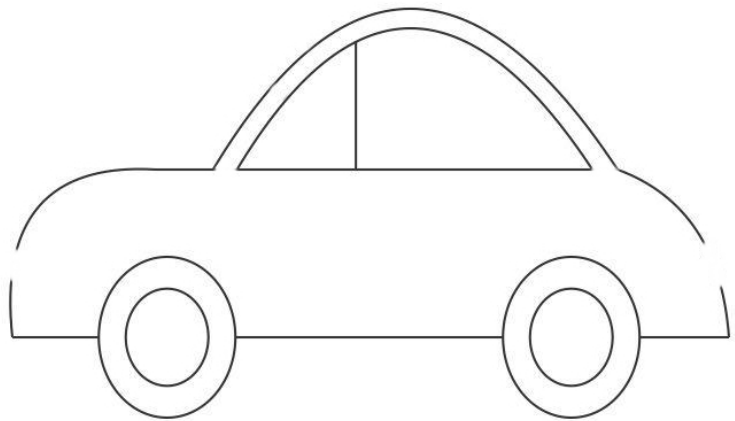
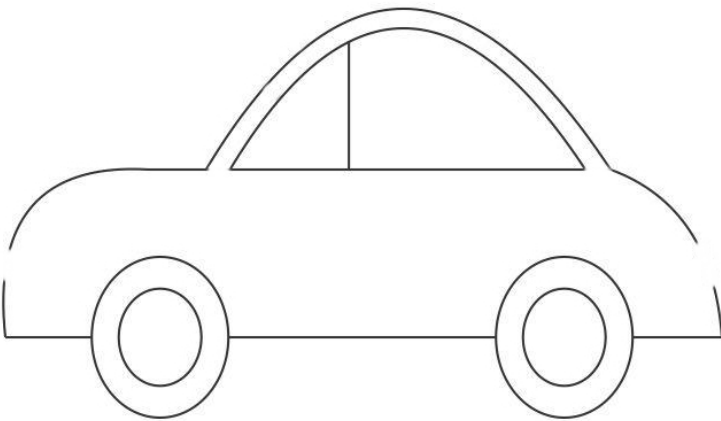
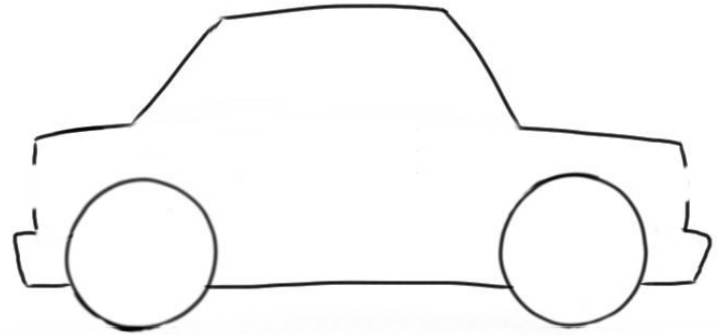
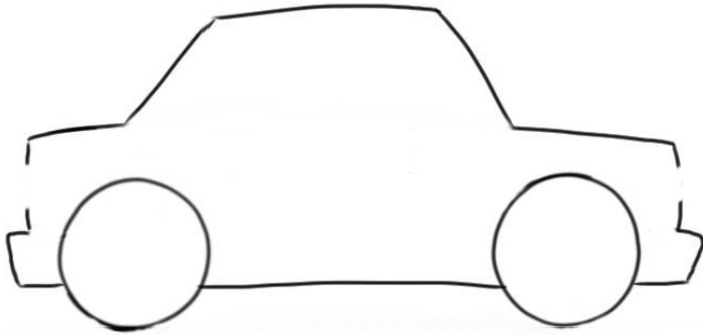
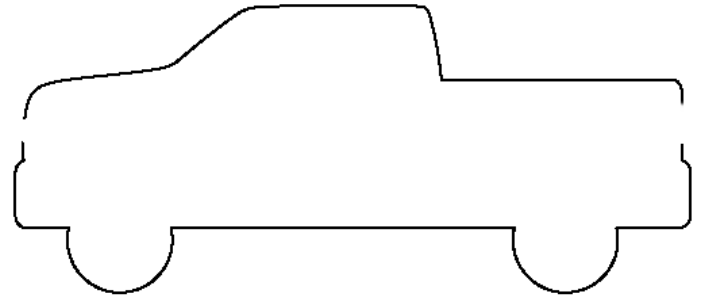
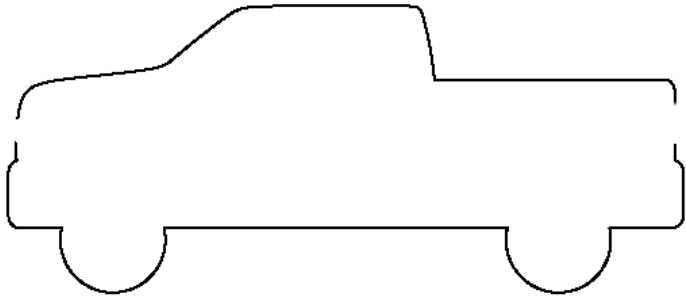
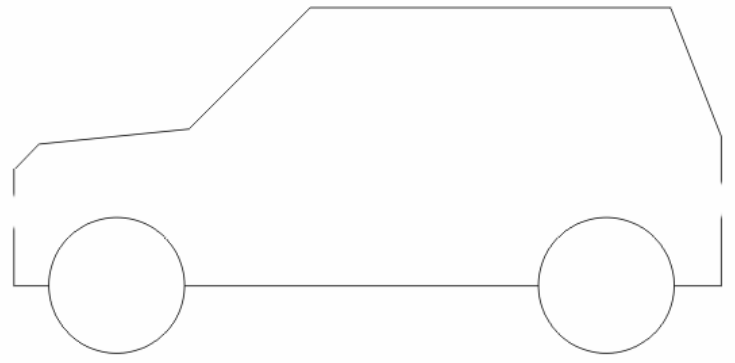
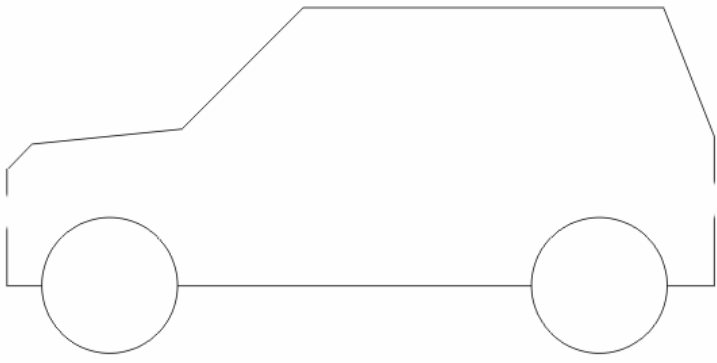
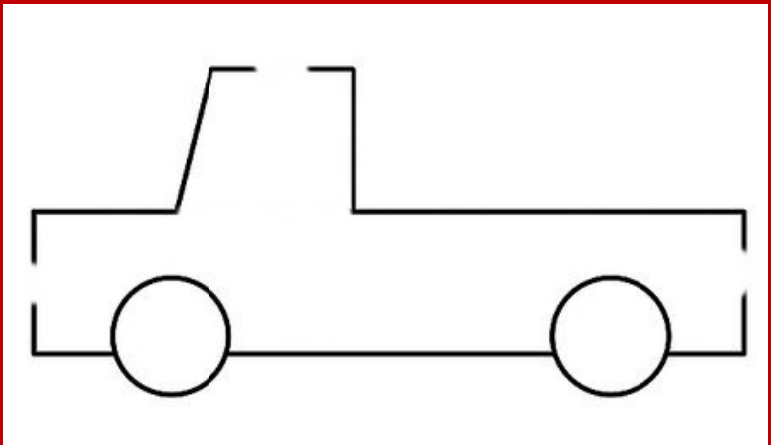
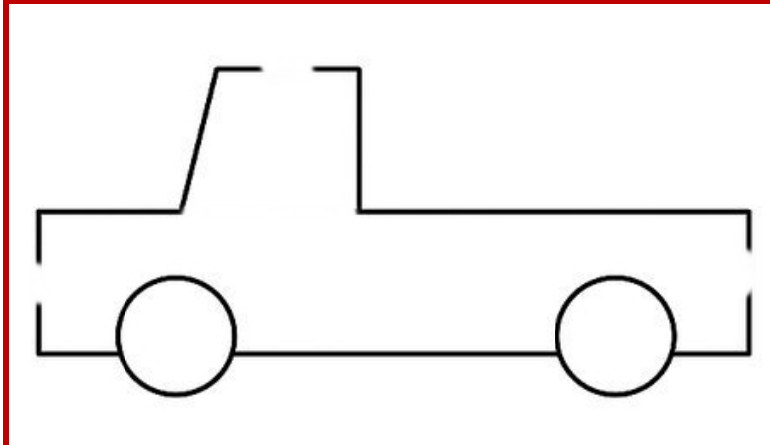
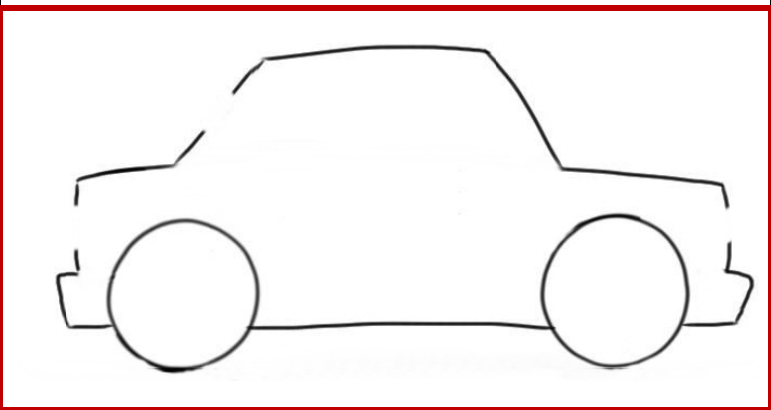
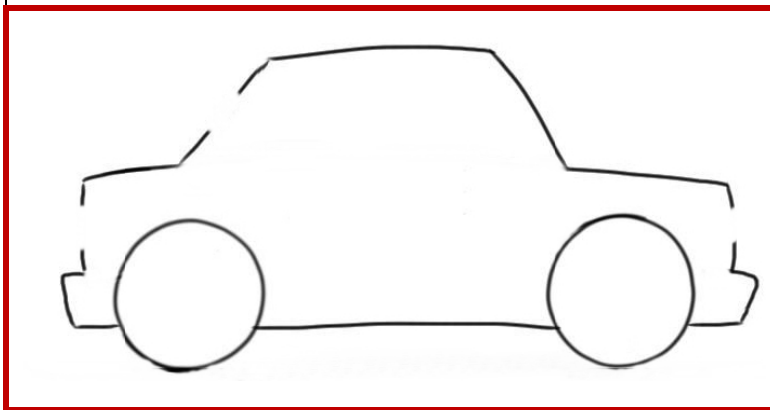
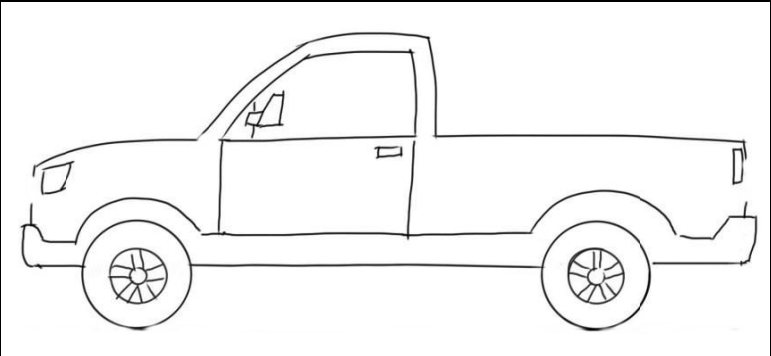
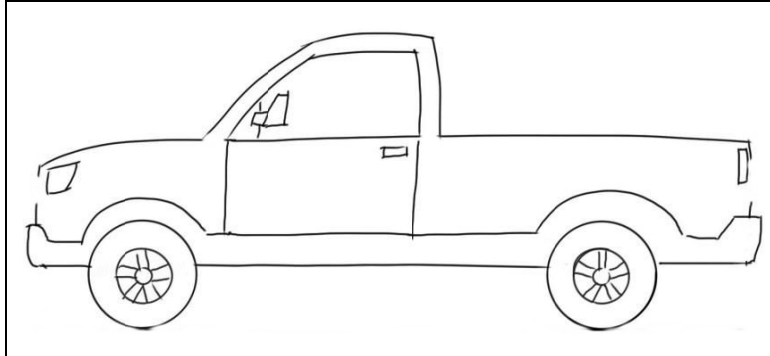
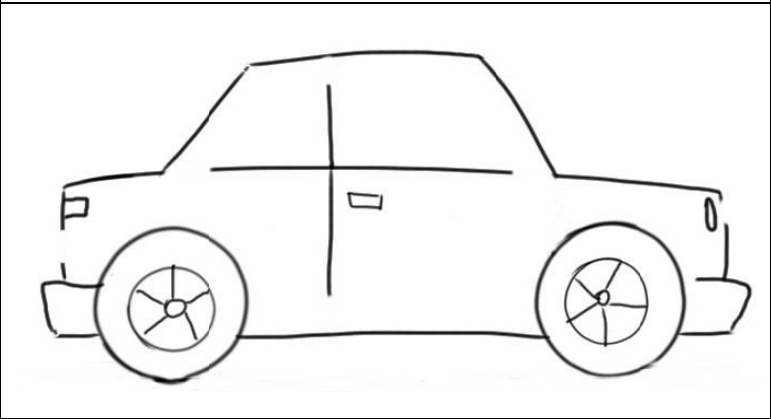
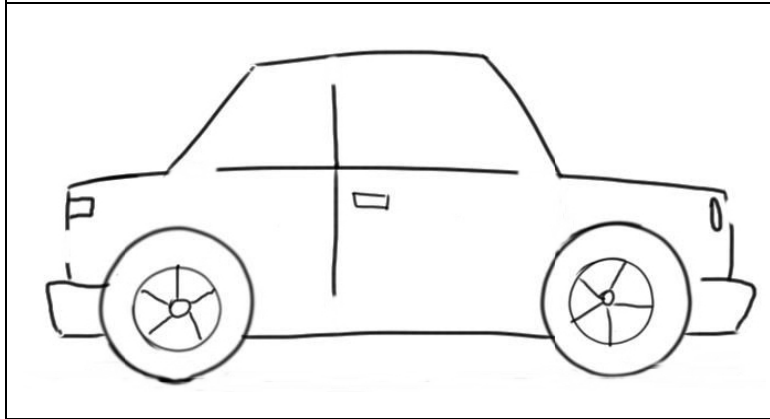
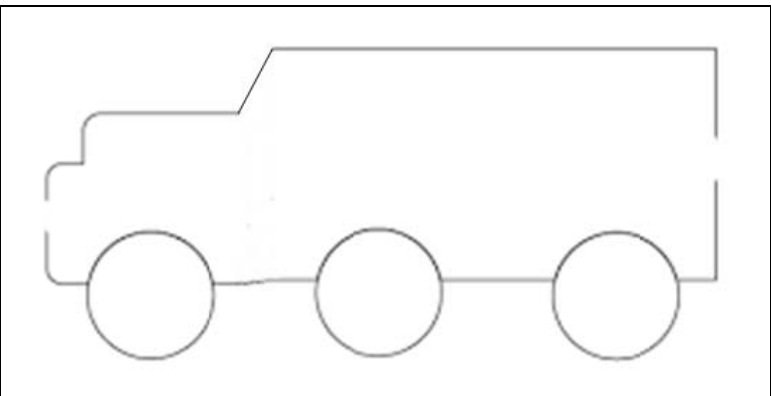
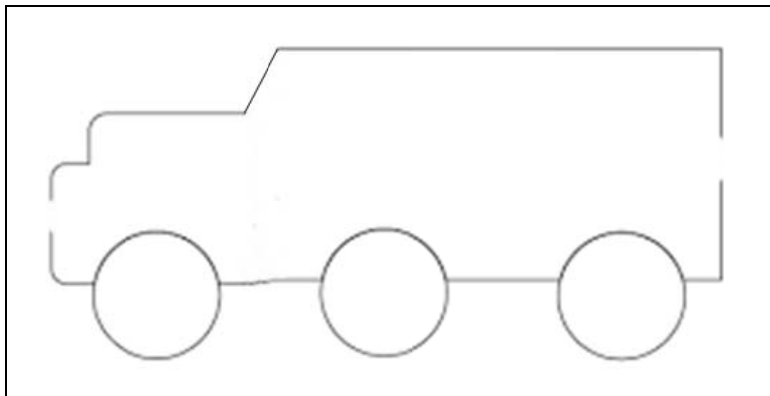

Στα παραπάνω "αυτοκινητομολυβοχαρτοκυκλώματα" θα χρειαστείτε μαλακό μολύβι (7H ή 8H) για να "μουτζουρώσετε" τα περιγράμμά τους, με πάχος γραμμών λίγο πάνω από μισό εκατοστό (0,6-0,7 cm). Τα **τελευταία 2 σκίτσα** έχουν "φώτα" μπροστά και πίσω, οπότε θα χρειαστείτε αντίστοιχα 2 LED λαμπάκια των 5mm (απλά, χαμηλής φωτεινότητας) και την μπαταρία των 9 Volt, όπως και σε όλα τα παραπάνω.